



MAHA BODHI SCHOOL
2021 SEMESTRAL ASSESSMENT 2
PRIMARY FIVE SCIENCE
(BOOKLET A)

Name : _____ ()

Class : Primary 5 _____

Date : 2 November 2021

Total Duration for Booklets A and B: 1 h 45 min

INSTRUCTIONS TO CANDIDATES:

1. Do not turn over this page until you are told to do so.
2. Follow all instructions carefully.
3. Answer all questions.
4. Shade your answers in the Optical Answer Sheet (OAS) provided.

This booklet consists of **19** printed pages.

BOOKLET A : [28 x 2 marks = 56 marks]

For each question from 1 to 28, four options are given. One of them is the correct answer. Make your choice (1, 2, 3 or 4). Shade your answer on the **Optical Answer Sheet**.

1. Which of the following parts gives a plant cell its shape?

- (1) nucleus
- (2) cell wall
- (3) cytoplasm
- (4) cell membrane

2. Two cells X and Y are shown.

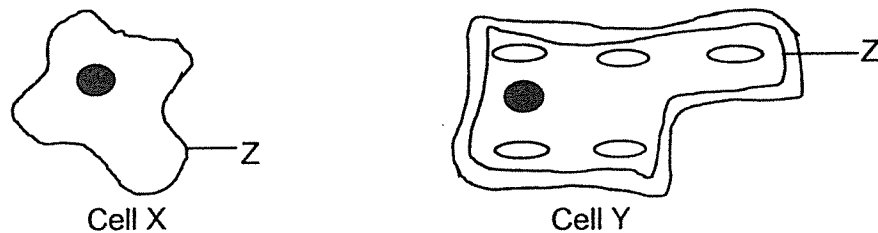

Which of the following correctly classifies the cells X and Y and the function of part Z?

	Animal cell	Plant cell	Function of part Z
(1)	X	Y	Controls substances in and out of cell
(2)	Y	X	Controls activities in a cell
(3)	X, Y	-	Controls substances in and out of cell
(4)	-	X, Y	Controls activities in a cell

3. Which of the following substances are transported by the human circulatory system?

- A. water
 - B. oxygen
 - C. digested food
 - D. carbon dioxide
- (1) A and D only
(2) B and C only
(3) B, C and D only
(4) A, B, C and D

4. Adrian was playing hide-and-seek. He decided to hide in his cupboard with the doors closed.

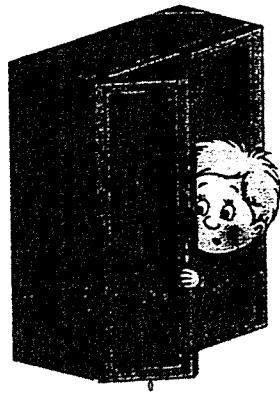

Which of the following correctly shows the amount of gases in the cupboard after 20 minutes?

	Oxygen	Water vapour	Carbon dioxide
(1)	increase	decrease	decrease
(2)	increase	increase	decrease
(3)	decrease	decrease	increase
(4)	decrease	increase	increase

5. An outer ring of the stem of a plant was removed at part R as shown below. She left the plant under the sun and watered it daily.

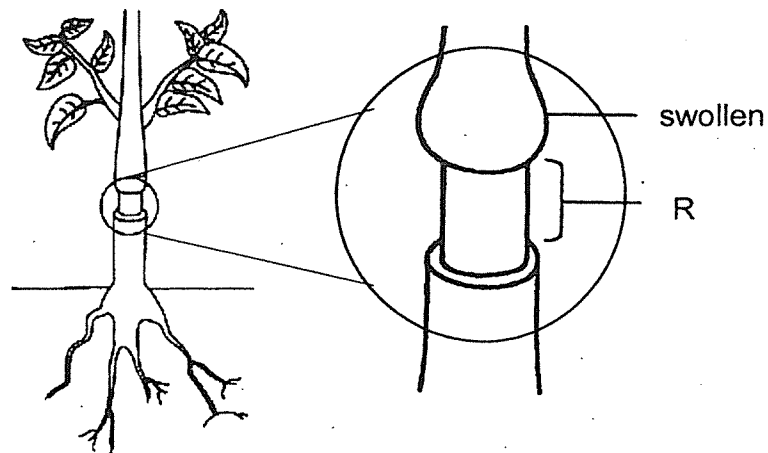

After a few days, it was observed that the plant was alive and the part of the stem above R was swollen. Which of the following is a possible reason?

- (1) Only the food-carrying tubes at R were removed.
 - (2) Only the water-carrying tubes at R were removed.
 - (3) No food-carrying or water-carrying tubes at R were removed.
 - (4) Both food-carrying and water-carrying tubes at R were removed.
6. Which of the following is not needed for a seed to germinate?
- (1) air
 - (2) water
 - (3) warmth
 - (4) sunlight

7. Study the diagrams of the female reproductive system and the plant reproductive system.

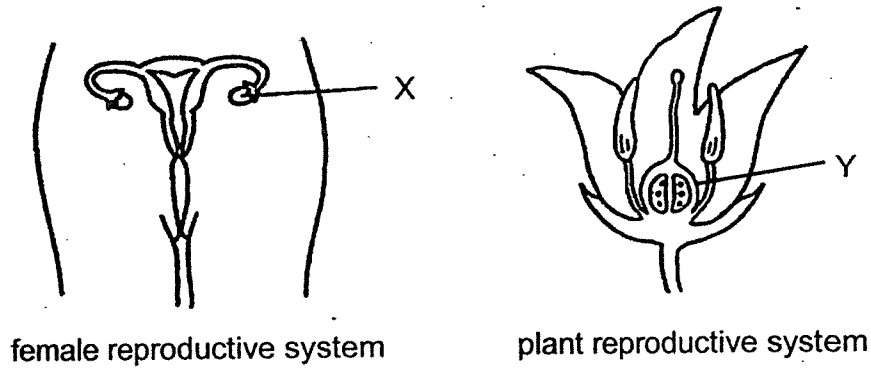

Which of the following statements about parts X and Y is correct?

- (1) Both produce male reproductive cells.
 - (2) Both contain the female reproductive cells.
 - (3) Both will be fertilised by the male reproductive cells.
 - (4) Both will develop into a new organism after fertilisation.
8. Study the fruit below.

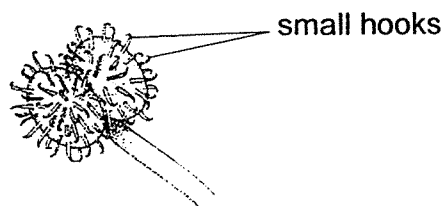

Based on the diagram, what is the dispersal method of the fruit?

- (1) wind
- (2) water
- (3) animal
- (4) splitting

9. Which of the following shows the life cycle of a grasshopper?

(1)

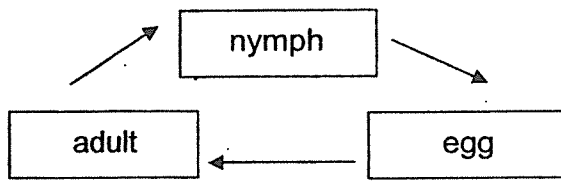

(2)

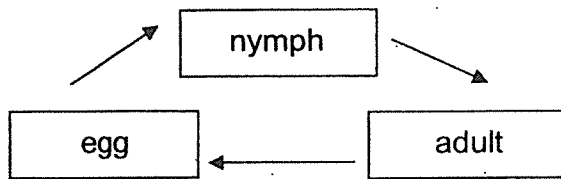

(3)

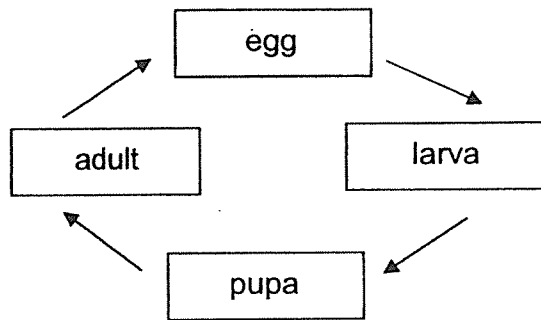

(4)

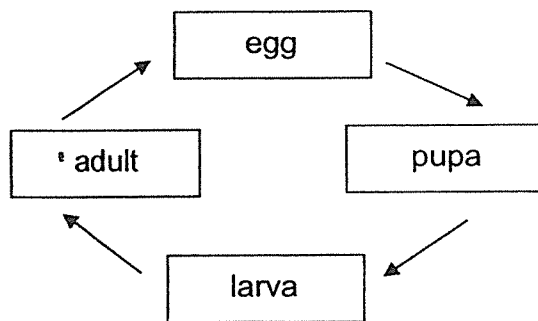

10. Thomas classified three types of cells as shown below.

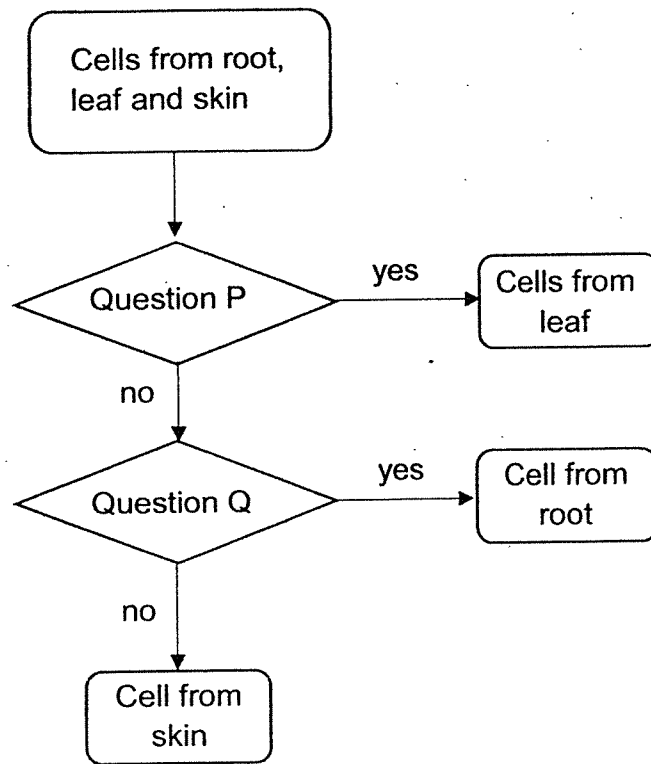

	Question P	Question Q
(1)	Does it have chloroplasts?	Does it have a cell wall?
(2)	Does it have a nucleus?	Does it have a cell membrane?
(3)	Does it have a cell membrane?	Does it have a nucleus?
(4)	Does it have a cell wall?	Does it have chloroplasts?

11. The diagram below shows the movement of blood in the human body system.

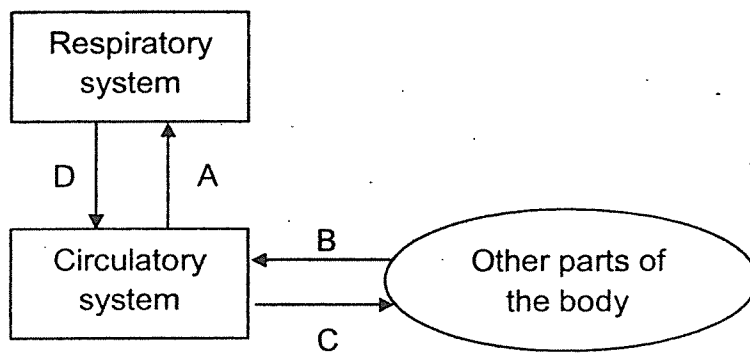

The same amount of blood was taken from A, B, C and D.

Which graph shows the correct comparison of the amount of carbon dioxide in the blood sample?

(1)

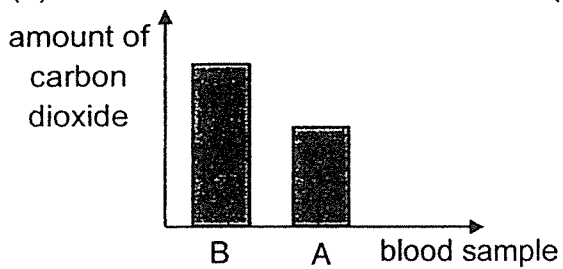

(2)

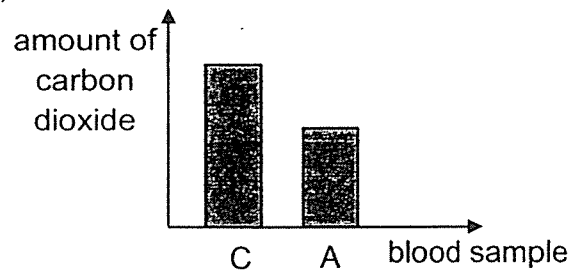

(3)

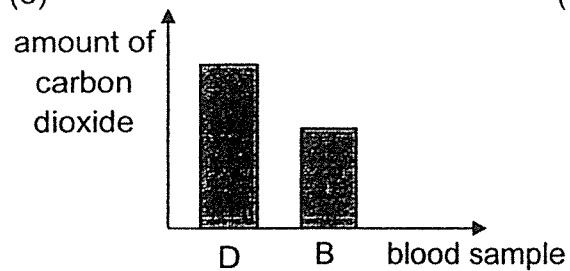

(4)

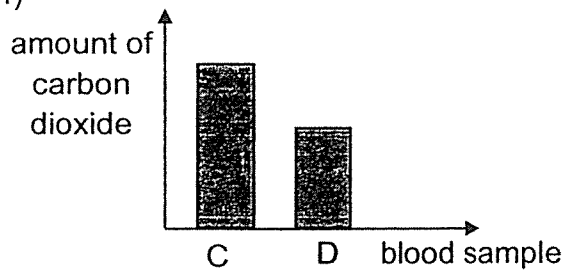

12. Jane removed two parts of a flower. She then rubbed pollen grains on the remaining parts. After a few days, she observed that a fruit was formed.

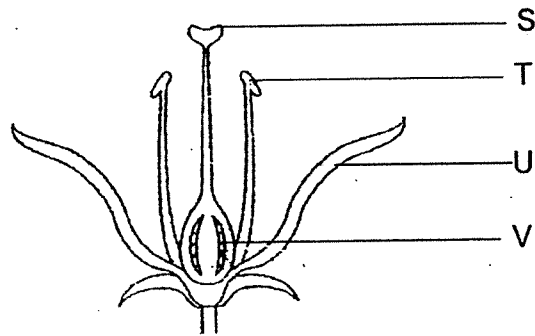

Which two parts of the flower were removed?

- (1) S and T
 - (2) S and V
 - (3) T and U
 - (4) U and V
13. Study the dispersal of seeds by plants D and E.

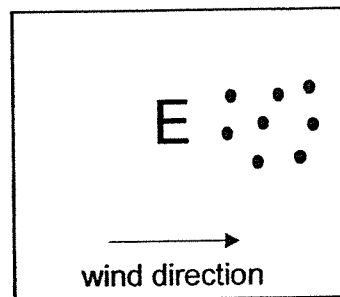
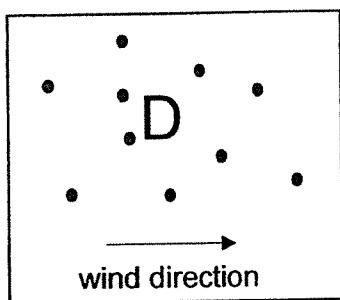

Based on the diagram above, which of the following shows the correct dispersal method by plants D and E?

	D	E
(1)	wind	animal
(2)	animal	splitting
(3)	splitting	wind
(4)	animal	wind

14. Study the flowchart below.

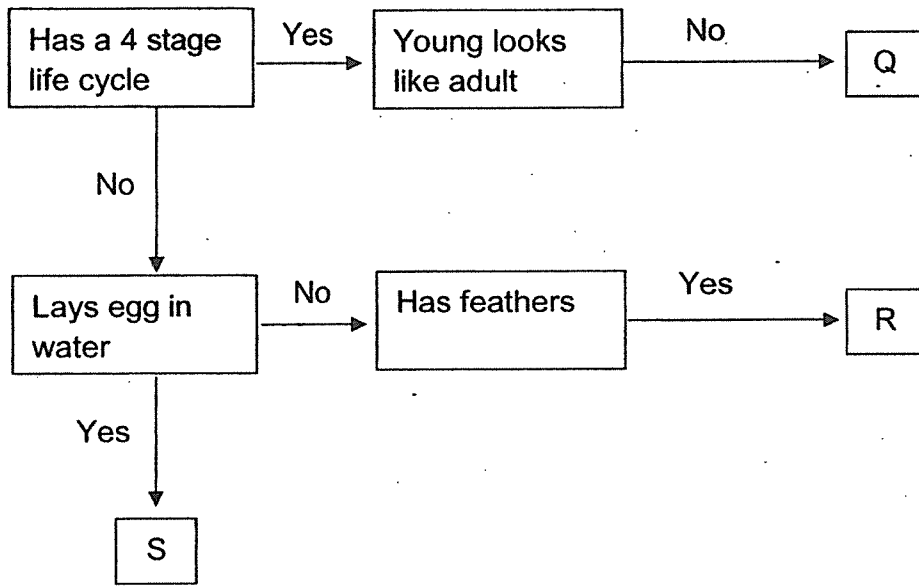

Based on the flowchart, what could Q, R and S represent?

	Q	R	S
(1)	grasshopper	chicken	frog
(2)	butterfly	cockroach	mosquito
(3)	mealworm beetle	butterfly	mosquito
(4)	butterfly	chicken	frog

15. The diagram below shows the human digestive system.

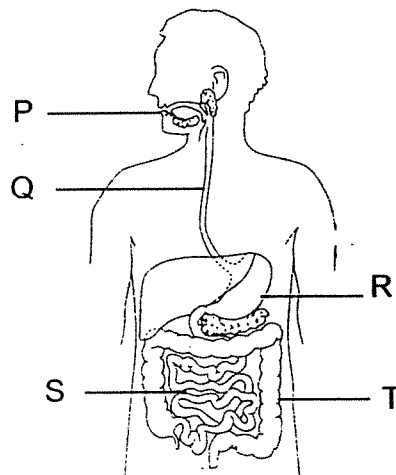

Identify the parts where digestion take place.

- (1) P and T only
 (2) P, R and S only
 (3) S, Q and T only
 (4) P, Q, R, S and T
16. Ashley wanted to investigate how the temperature of the surrounding air affect the rate of evaporation of water in a container. The following table shows the variables in 4 set-ups, W, X, Y and Z.

Variables	Set-ups			
	W	X	Y	Z
Amount of water in container (cm ³)	200	200	200	150
Exposed surface area of water in container (cm ²)	50	100	50	50
Temperature of water (°C)	10	28	10	28
Temperature of surrounding air (°C)	30	30	20	30

Which 2 set-ups should she use to conduct her investigation?

- (1) W and X
 (2) W and Y
 (3) X and Y
 (4) Y and Z

17. Darren heated a beaker containing 200 ml of tap water. He recorded the temperature of the tap water as shown in the graph below.

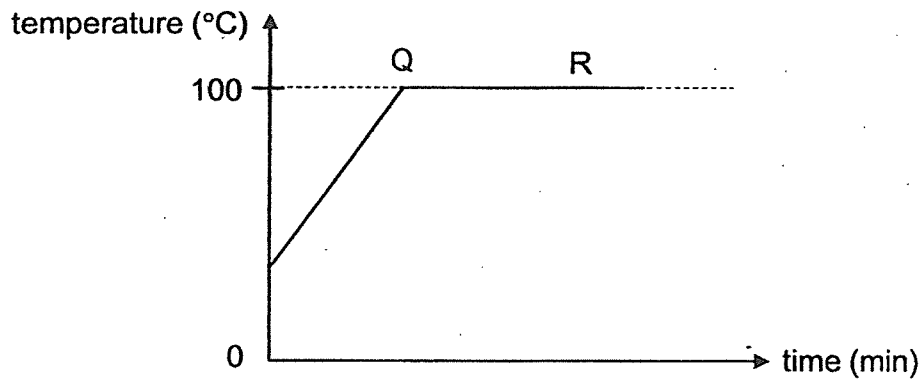

Based on the graph, what is the process that took place at QR?

- (1) boiling
 - (2) melting
 - (3) freezing
 - (4) evaporation
18. In which circuit will the bulb light up?

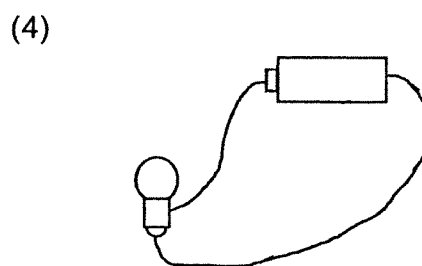
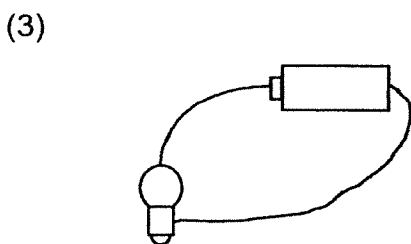
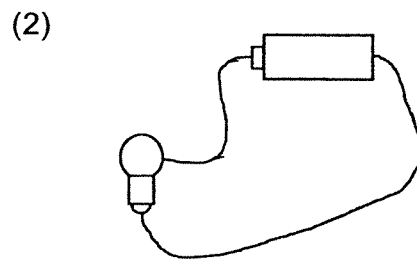
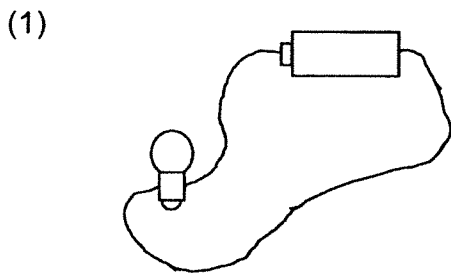

19. Jason wanted to find out if the number of times a magnet was dropped on the ground affects its strength.

He dropped a magnet from the same height and recorded the number of pins it could attract after the drop. The graph shows his results.

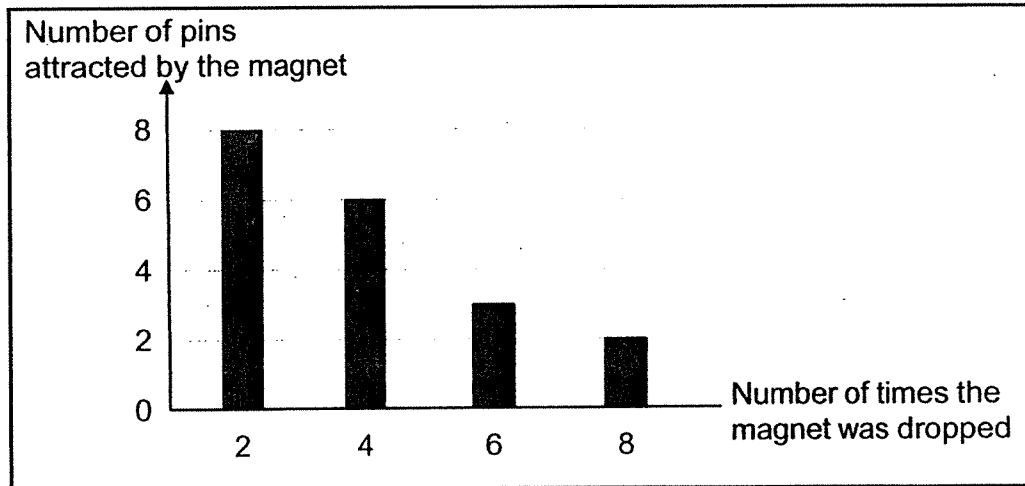

Based on the results, what could Jason conclude?

- (1) The magnet could attract 8 pins before dropping.
- (2) After dropping the magnet 2 times, it attracted 6 pins.
- (3) After dropping the magnet more than 3 times, it attracted less than 8 pins.
- (4) After dropping the magnet more than 8 times, it could not attract any pins.

20. The diagram below shows 3 containers A, B and C of different capacities.

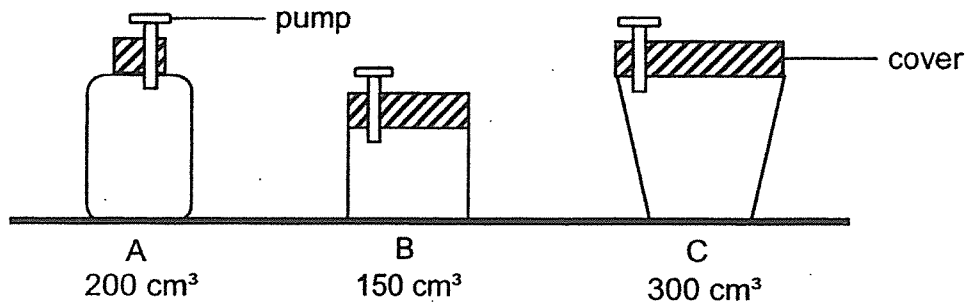

Which of the container(s) A, B or C can hold all the 200 cm³ of air when it is pumped into them?

- (1) A only
 - (2) C only
 - (3) A and C only
 - (4) A, B and C
21. The table below shows the freezing points of three substances, X, Y and Z.

Substance	Freezing point (°C)
X	15
Y	40
Z	150

Based on the above information, which of the following is correct?

- (1) X is a gas at 50 °C.
- (2) X and Y are both liquid at 50 °C.
- (3) Y and Z are both solid at 38 °C.
- (4) Z can be a liquid or a gas at 150 °C.

22. Ramlli poured 200 ml of water into each of the four different containers P, Q, R and S. He left the containers next to a window for a day. The graph below shows the amount of water left in the containers at the end of the next day.

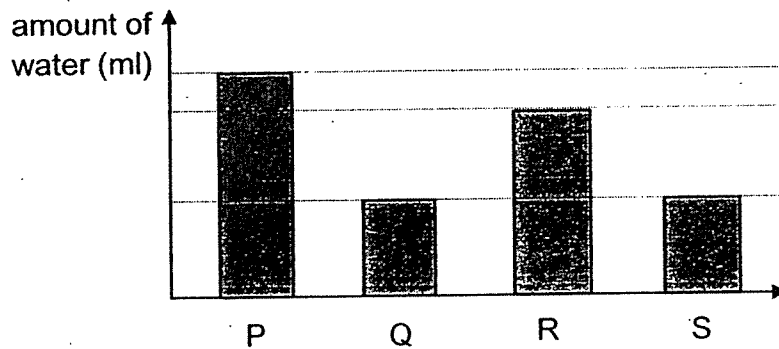

Based on the results above, which of the following statements are true?

- A. The water in container P evaporates the fastest.
- B. Both containers Q and S are made of the same material.
- C. The water in container Q and S have the same rate of evaporation.
- D. The rate of evaporation of water in container R is faster than that in container P.

- (1) A and B only
- (2) C and D only
- (3) A, B and C only
- (4) B, C and D only

23. The diagram below shows a circuit.

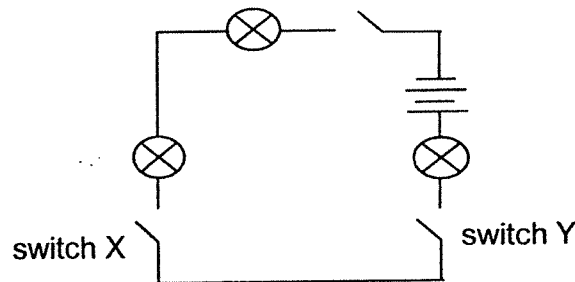

What is the most number of bulbs lit if only switches X and Y are closed?

- (1) 0
- (2) 1
- (3) 2
- (4) 3

24. Four metal clips, A, B, C and D were fixed onto a cardboard as shown in Figure 1 below. Figure 2 shows a battery and a bulb connected to two wires E and F.

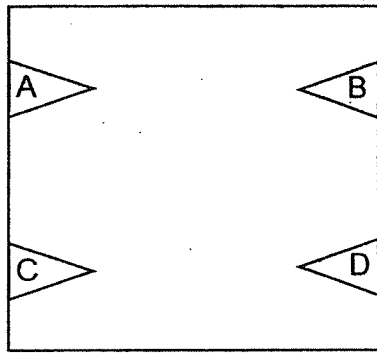

Figure 1

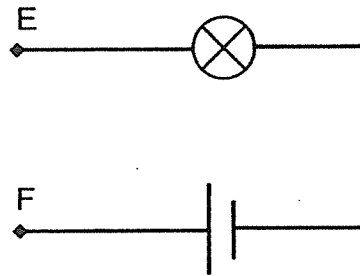

Figure 2

The table below shows what happened when E and F were connected across different pairs of clips.

Clip connected to E	Clip connected to F	Did the bulb light up?
A	B	Yes
B	C	Yes
C	D	No
A	D	No

Which of the following correctly shows the connections made?

(1)

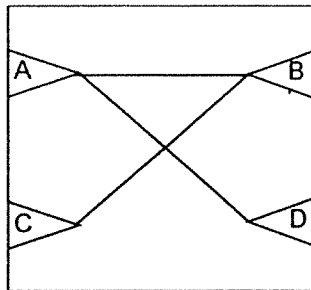

(2)

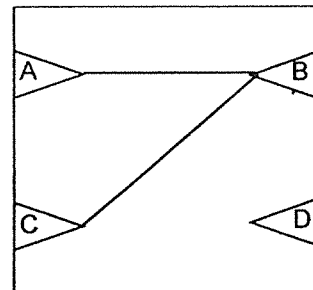

(3)

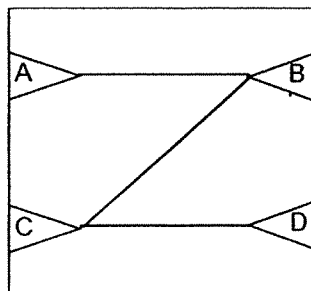

(4)

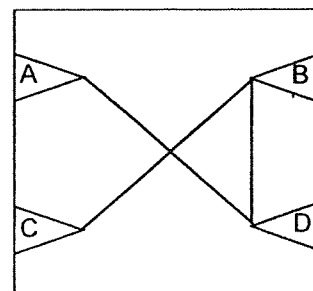

25. The diagram below shows three sheets, J, K and L, with different shapes cut in the middle. All the sheets are made of different materials but only one sheet is made of material that allows most light to pass through.

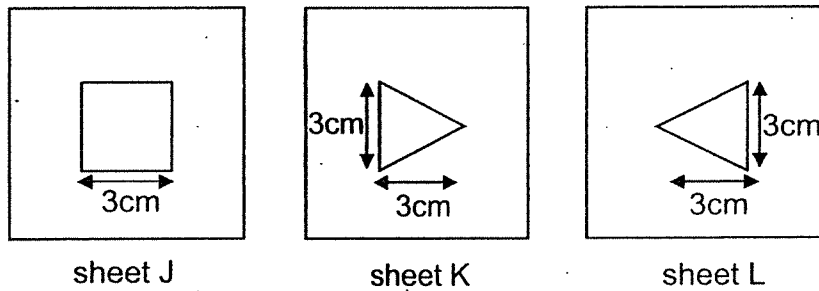

The sheets were then glued together and light was shone at them.

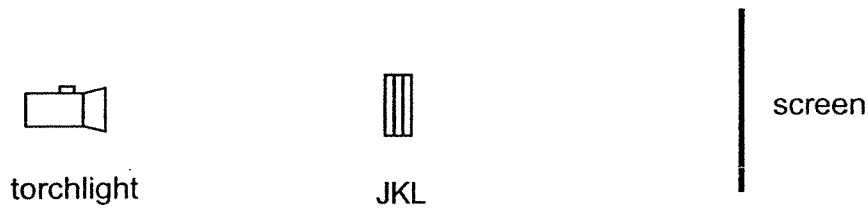

Which of the following could be seen on the screen?

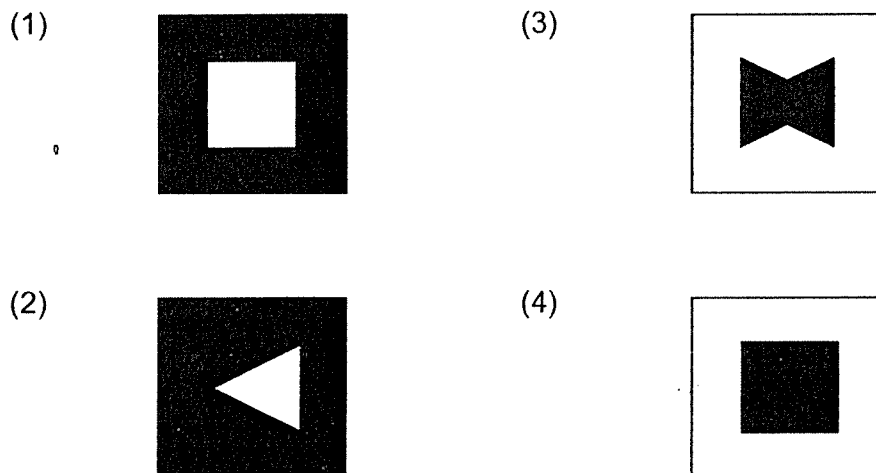

26. Jenny heated two beakers of water, M and N, using a hotplate and recorded the time taken for both beakers to reach 100°C . He then removed the beakers from the hotplate and left them on the same table to cool.

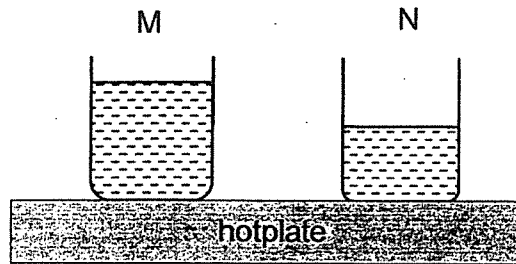

Which of the following statement(s) is/are correct?

- A. M reached 100°C faster than N.
 - B. N will reach room temperature faster than M when left to cool.
 - C. The water in both beakers have the same amount of heat at 100°C .
- (1) A only
(2) B only
(3) A and C only
(4) B and C only

27. Muthu put a bowl of hot curry into two boxes made of different materials.

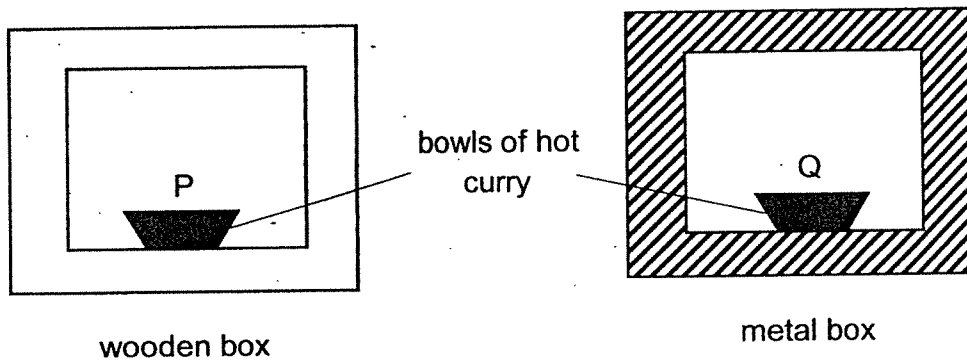

Which of the graphs below shows the change in temperature for the two bowls of curry over a few hours?

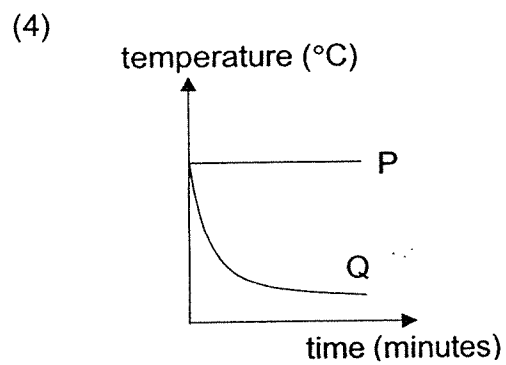
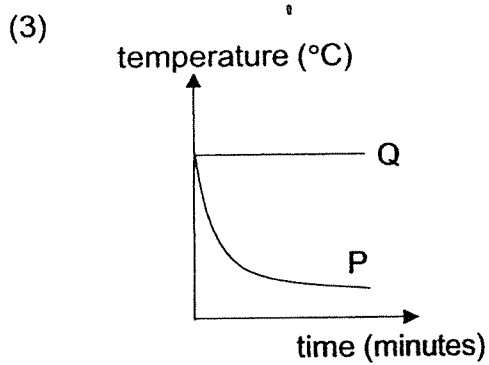
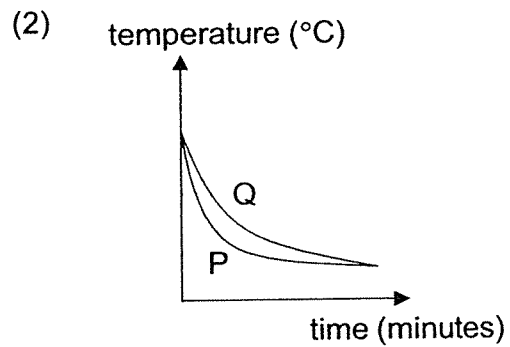
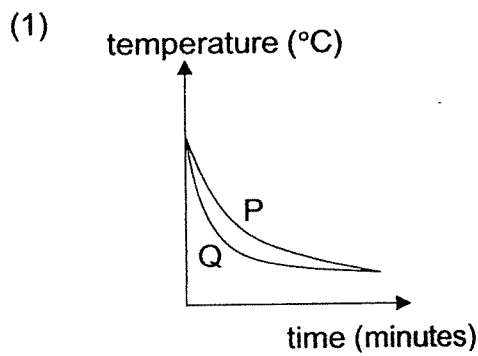

28. The set-up below was used to test how much water a material absorbs.

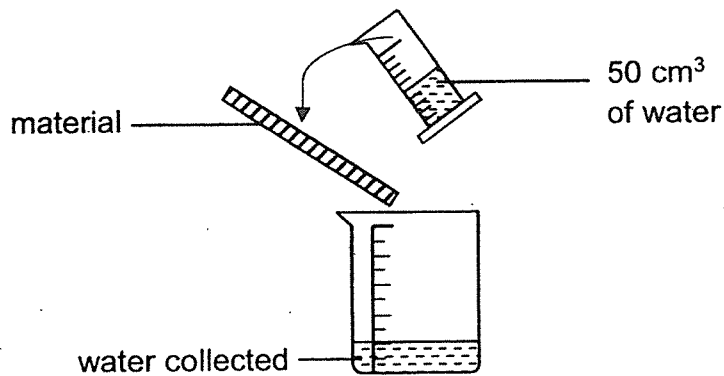

50 cm³ of water was poured carefully onto the material. Any water not absorbed by the material was collected in the beaker.

When there was no more water left on the material, the amount of water collected in the beaker was measured. The results are shown below.

Material	R	S	T	U
Amount of water collected (cm ³)	35	0	19	50

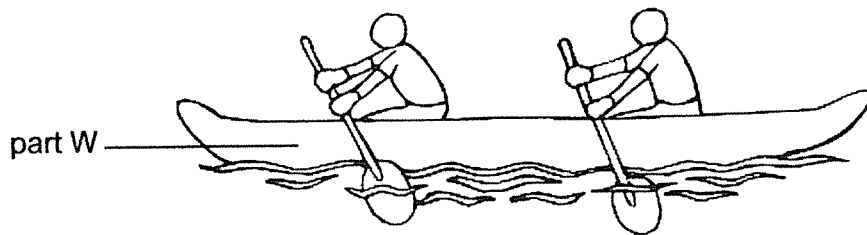

Which one of the materials should be used to make part W of a boat shown above?

- (1) R
- (2) S
- (3) T
- (4) U

END OF BOOKLET A

GO ON TO BOOKLET B



MAHA BODHI SCHOOL
2021 SEMESTRAL ASSESSMENT 2
PRIMARY FIVE SCIENCE
(BOOKLET B)

Name: _____ ()

Class: Primary 5 _____

Date : 2 November 2021

Total Duration for Booklets A and B: 1 h 45 min

INSTRUCTIONS TO CANDIDATES:

1. Do not turn over this page until you are told to do so.
2. Follow all instructions carefully.
3. Answer all questions.
4. Write all your answer in this booklet.

Booklet	Marks Obtained	Max Marks
A		56
B		44
Total		100

Parent's signature: _____

This booklet consists of **14** printed pages.

BOOKLET B : [44 marks]

For questions 29 to 40, write your answers in this booklet.

The number of marks available is shown in the brackets [] at the end of each question or part-question.

29. (a) Stephen made a model of the human respiratory system shown below.

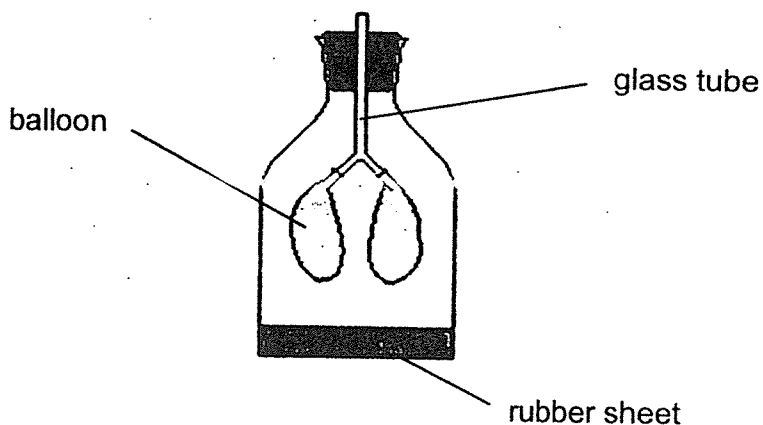

- (a) Which organs of the human respiratory system represent the following parts of the model? [1]

(i) balloon

(ii) glass tube

- (b) Explain why Stephen's breathing rate increases when he exercises? [2]

Marks :

/ 3

30. The table below shows the amount of oxygen in the air at different heights above the sea level.

Height above sea level (metres)	Amount of oxygen available in the air (%)
0	20.9
1000	18.4
4500	11.9
7000	8.2
9500	6.8

<https://altitudedream.com/en/altitude-to-oxygen-chart>

- (a) Based on the table, what is the relationship between the height above sea level and the amount of oxygen in the air? [1]

- (b) Mount Everest is about 8800m above sea level, what is the possible amount of oxygen found in the air at the top of the mountain? [1]

- (c) A mountaineer climbing Mount Everest discovers that his heart beats faster as he goes higher above the sea level.

Based on the information given above, explain why this is so? [2]

Marks :

/ 4

31. The diagrams below show the male flower and female flower of a plant.

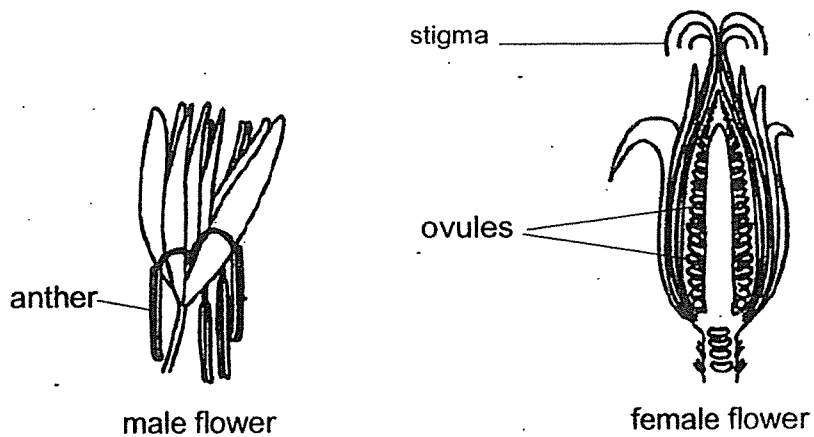

- (a) Based on the diagram, explain why it can be concluded that the fruits of the plant has many seeds. [1]

- (b) Based on the diagram, are the flowers pollinated by animal or wind? Explain your answer. [2]

Marks :

/ 3

32. (a) Why is it important for plants to disperse their seeds? [1]

(b) Miriam counted the number of young plants C and D at various distances from their parent plants in a forest. The results are shown below.

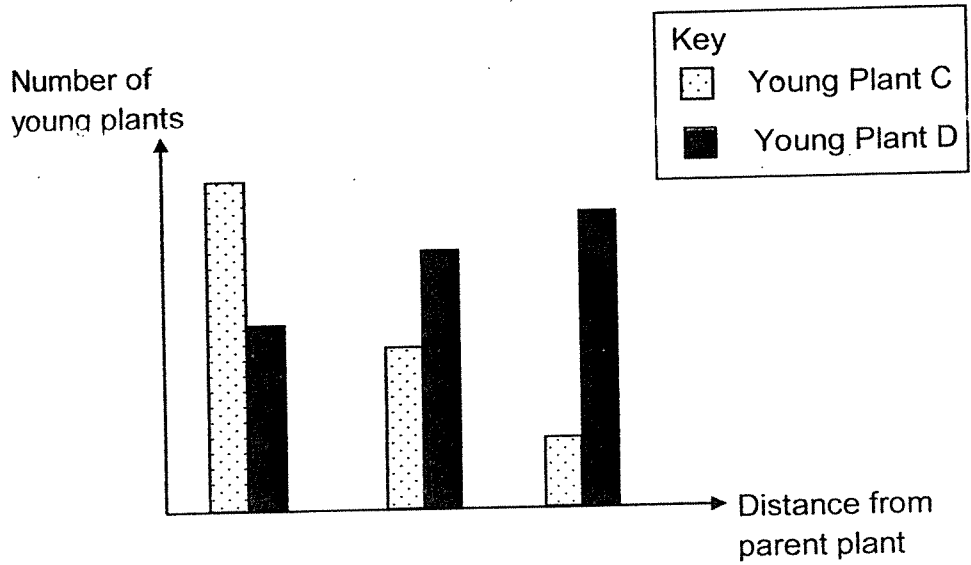

The fruits of Plant C and D are shown below. Both have dry pods.

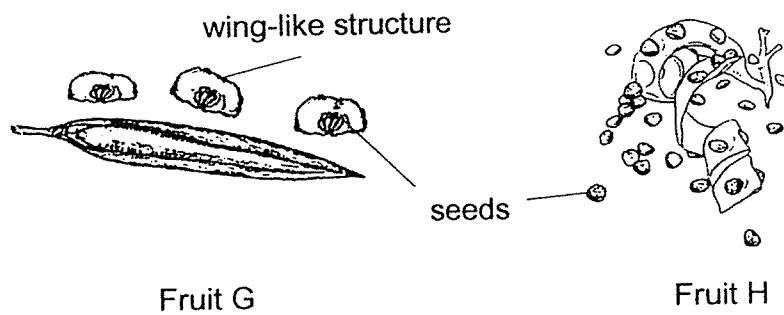

Which fruit belongs to Plant D? Explain why. [2]

Marks : / 3

33. A block of ice was placed in an empty plastic container and left in the classroom.

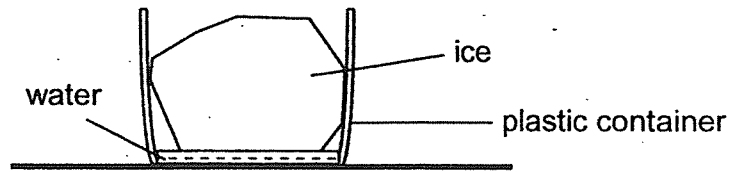

- (a) What is the temperature of the water around the block of ice after 5 minutes? [1]

- (b) Describe how water droplets appeared on the outer surface of the plastic container. [2]

When the same block of ice was broken into many smaller pieces of ice, it took a shorter time for the ice to melt.

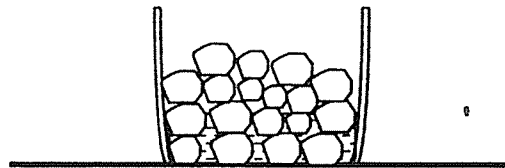

- (c) Explain why it took a shorter time for the smaller pieces of ice to melt. [1]

Marks :

/ 4

34. Suzy conducted an experiment to investigate how 'bubble wrap' affects the temperature of water. She used two identical containers as shown below. Container C was covered with 'bubble wrap' that contains pockets of air while container D was covered with 'bubble wrap' without pockets of air. Both containers were filled with 200 ml of water at 80°C.

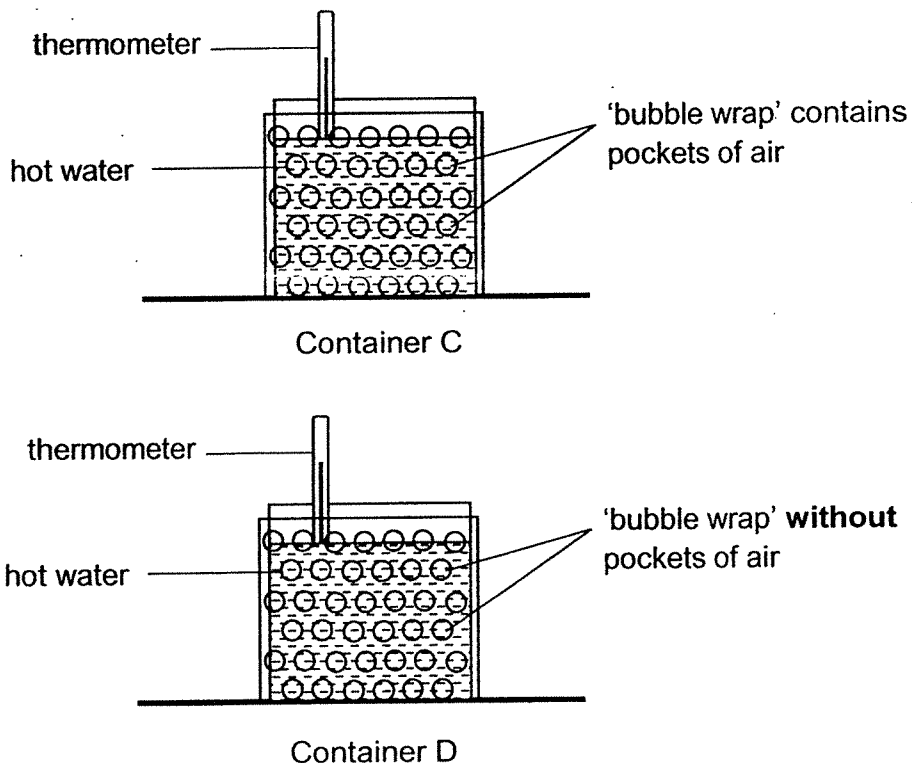

- (a) What are the variables that has to be the same for a fair test? [1]

Variables	Tick (✓) the variables to keep the same
amount of water	
temperature of water	
size of beaker	

- (b) Explain why Suzy needs to conduct her experiment in the same location? [1]

Marks : / 2

- (c) Suzy recorded the temperature of water in containers C and D over time in the graph shown below.

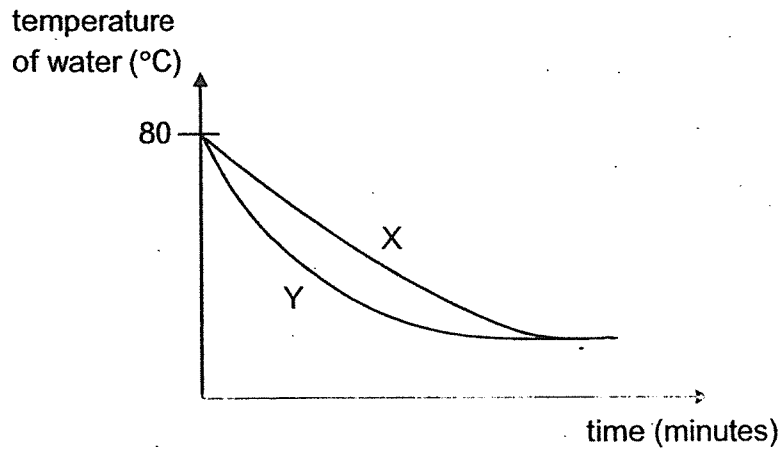

Which graph, X or Y, shows the correct results for the container wrapped with the 'bubble wrap' containing the pockets of air? Explain your answer. [2]

Marks :

12

35. Gopal wanted to find out if bars Q, R, S, T and V are either electrical conductors or insulators. He set up the circuit as shown below.

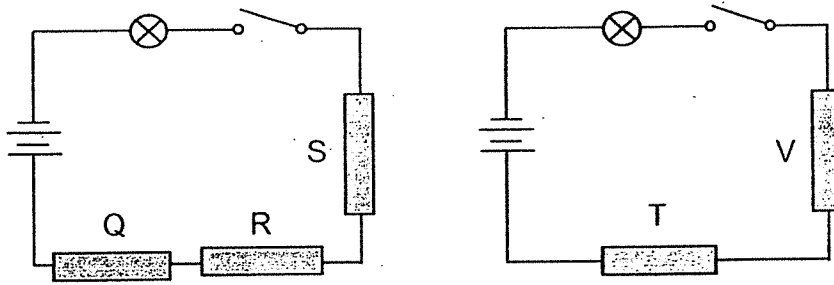

He closed the switch and removed some of the bars. The table below shows his observation when some bars are removed from the circuit.

Bar(s) removed from the circuit	Did the bulb(s) light up?
Q, S	yes
R, S	no
T	no
Q, R, V	yes

- (a) What is an electrical conductor? [1]



- (b) Complete the table below with Q, R, S, T and V. [2]

Electrical conductor(s)	Electrical insulator(s)

Marks : / 3

(c) Gopal used the same bar Q in the following circuit.

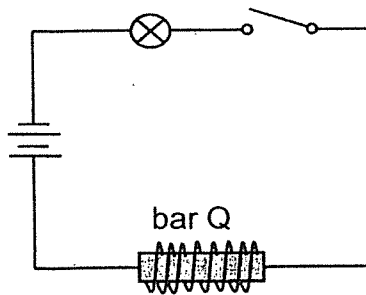

He closed the switch and lowered bar Q into a tray of steel clips.

Describe what Gopal will observe when he lowered bar Q into a tray of steel clips. Explain your answer. [2]

Marks :

2

36. (a) A container with ice was left in the classroom as shown in figure 1. Figure 2 below shows the same container after 3 hours.

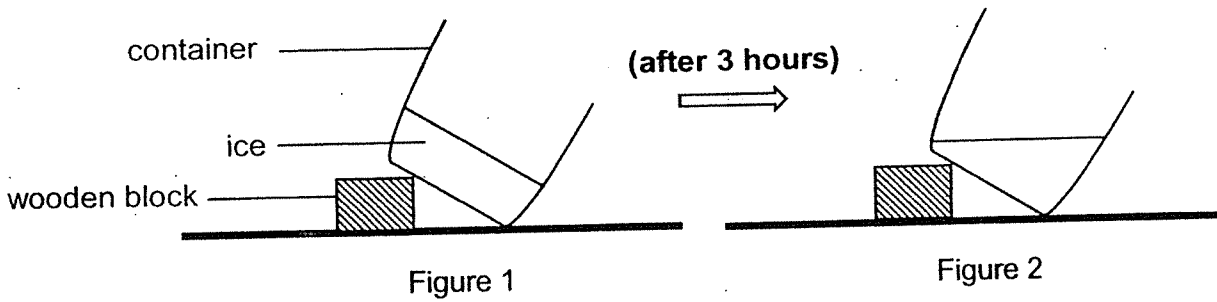

State the change in state of the ice observed from figure 1 to 2. [1]

- (b) A funnel was attached to a sealed container. Some water was poured into the funnel. However, only a few drops of water entered the container as shown below.

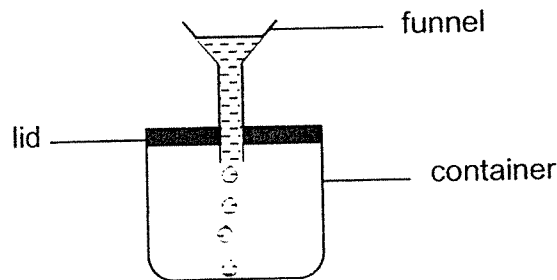

- (i) Explain why only a few drops of water could enter? [1]

- (ii) What could be done to allow more water to enter the container without adding or removing any of the items shown in the diagram above? Explain your answer. [2]

Marks :

/ 4

37. Mary walked in a straight line from X to Z as shown in the diagram below. At Y, she was directly under the lamp. The distance between X and Y is the same as Y and Z.

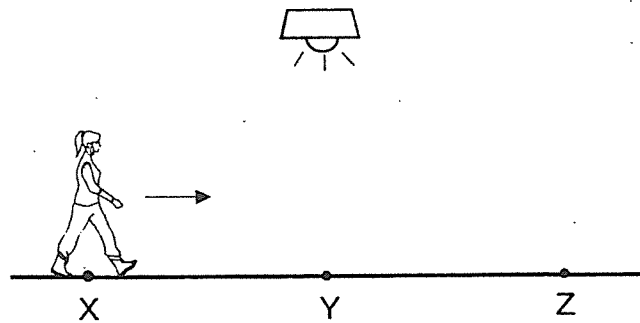

The graph below shows how the length of her shadow on the ground changed as she walked.

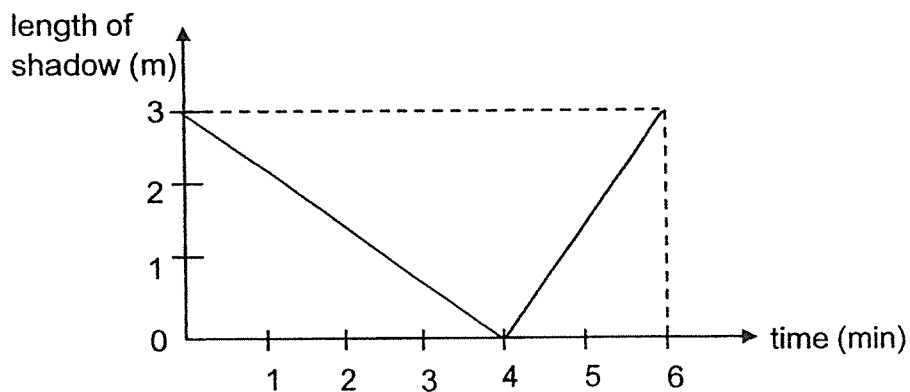

- (a) How is a shadow formed? [1]

- (b) Based on the graph, what is the length of her shadow when she is directly under the lamp? [1]

- (c) Based on the graph, describe the change in the length of her shadow as she was walking from X to Y and Y to Z. [1]

Marks :

/ 3

38. (a) Felicia had two similar sheets, G and H, made of the same material. She placed the sheets on a heater as shown below.

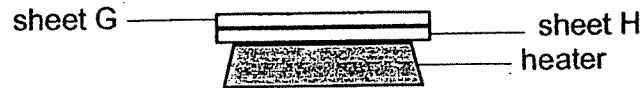

At the beginning, sheets G and H were the same length. After a while, sheet H became longer than sheet G.

Explain why sheet H became longer than sheet G. [2]

- (b) Felicia took out a thick-walled glass out of the fridge. She wanted to use it to keep her drink cold for longer.

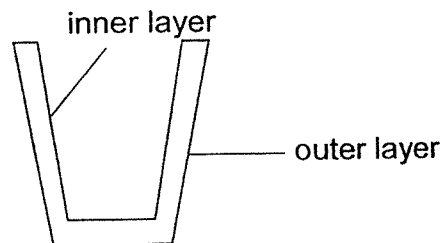

However she accidentally poured very hot water into the glass. The inner layer of the glass cup cracked.

Explain why the inner layer glass cracked and not the outer layer when she poured hot water in. [2]

Marks : / 4

39. Melvin carried out an experiment by placing each material X, Y and Z over the edge of a table. The material is taped firmly on edge the table top. When a block is hung at the end of the material, it bent as shown in the diagram below.

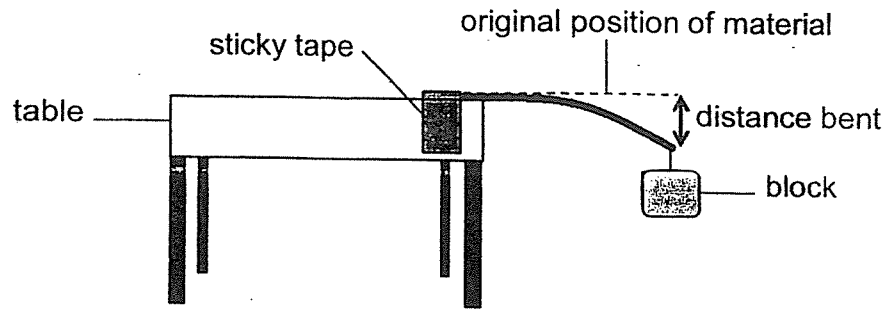

The distance that each sheet of material could be bent without breaking was recorded in the table below.

Material	X	Y	Z
Distance bent (cm)	5	0	2

- (a) Which property of the material is Melvin testing? [1]

- (b) State one variable that should be kept the same for a fair test. [1]

- (c) The diagram below shows a table.

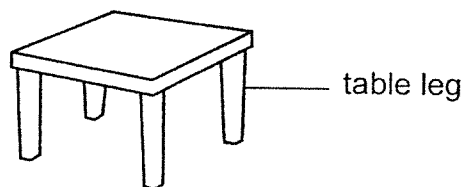

Based on the results above, which material, X, Y or Z, would be most suitable to make the table leg? Explain your answer. [2]

Marks :

	/ 4
--	-----

40. The diagram below shows a pair of ring magnets G and H on a stand.

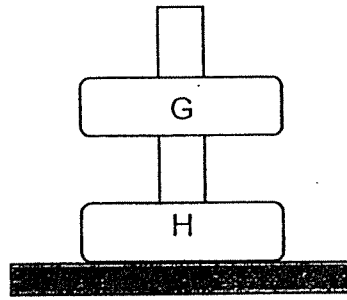

(a) Explain why G is able to float on H? [1]

(b) An unknown ring K was placed on top of G as shown in the diagram below.

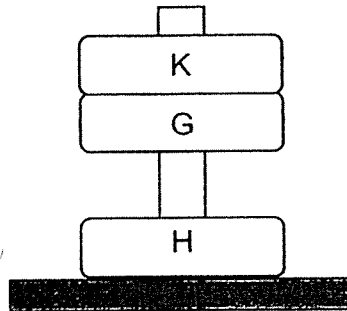

Roger concluded that K is also a magnet since it is attracted to G. His teacher told him that his conclusion may not be right.

Using the same setup and without removing G and H, describe what Roger can do to confirm that K is a magnet. [2]

Marks :

/ 3

~ END OF PAPER ~

This is the property of Maha Bodhi School.

No part of this should be duplicated without the permission of the school.

1.	2	6.	4	11.	4	16.	2	21.	3	26.	2
2.	1	7.	2	12.	3	17.	1	22.	2	27.	1
3.	4	8.	3	13.	4	18.	4	23.	1	28.	4
4.	4	9.	2	14.	4	19.	3	24.	2		
5.	1	10.	1	15.	2	20.	4	25.	2		

29	a	i	Lung(s)
	b	ii	Wind pipe
30	a		During exercise, he breathes faster to take in/breathe in more oxygen for respiration. At the same time, his lungs/body needs to remove carbon dioxide that is produced by his body quickly.
	b		The amount of oxygen in the air decrease as the height above sea level increases.
	c		Any value between 6.8 – 8.2% (exclude 6.8% and 8.2%)
31	a		The amount of oxygen has become lesser as he climbs higher.
	b		His heart needs to beat faster to transport blood that contain enough/sufficient oxygen to his body.
32	a		The (female) flower / The ovary has many ovules. Ovules developed into seeds.
	b		Wind-pollinated. The anther that is outside and exposed to the wind and the stigma that sticks out. These characteristics increase the chances of pollen grains being blown by wind to the stigma.
33	a		So there will be less competition for water, light, space and mineral salts/nutrients.
	b		Fruit G. Plant D has more young plants further from the parent plant. The seeds of Fruit G have a wing-like structure but the seeds of Fruit H do not/unlike Fruit H. So the wind will carry the seeds of Fruit G further from parent plant after splitting.
	c		0°C
34	a		The water vapour in the surrounding air lose heat to the cooler (outer) surface of the plastic container and condenses to become water droplets.
	b		There is more exposed surface area of the ice to gain heat from the surrounding air to melt.
	c		All the variables must tick.
	b		To ensure that any change in the temperature of water is due to the presence of air in the bubble wrap as the temperature of the surrounding air can affect the temperature of the water in the beaker.
	b		To ensure that the temperature of the surroundings does not affect the results of the experiment.

35	c		Graph : X shows that the temperature of water decreases slower than graph Y. Air is a poor conductor of heat/not a good conductor. The hot water in the beaker will lose heat slower (to the surrounding).
	a		An electrical conductor allows electricity to flow through it.
	b		Electrical Conductor Electrical Insulator
			R, S, T Q, V

36	a		The clips was not attracted. Non-metals are not magnetic so Q cannot be magnetised.
	b		Ice changed from solid to liquid.
	i		The air in the container occupies space / air could not escape from the container.
	ii		Air occupies space and water cannot enter the container / there was not enough space for the water. Make a hole at the lid / container so that air can escape and water can occupy the space previously occupied by the escaping air / air can be displaced by water.
37	a		When the path of light is blocked by an opaque object, a shadow is formed.
	b		0 m
	c		The length of her shadow decreased from X to Y and the length of her shadow increased as she walked from Y to Z
38	a		Sheet H gained more heat/gained heat faster and expanded more
	b		The inner layer gained heat first so the inner layer expanded faster than the outer layer causing it to crack.
39	a		There was uneven expansion of the layers which caused the inner layer to crack
	b		flexibility
	c		Thickness of material
40	a		Material Y. It did not bend at all. Table legs should not bend/stiffness
	b		The like poles of the magnets are facing each other.
	b		He can flip. He should observe it floating above G. Only magnet can repel another magnet.

1
END